

Motorised Skylight Shading System

Silent Gliss® 8700

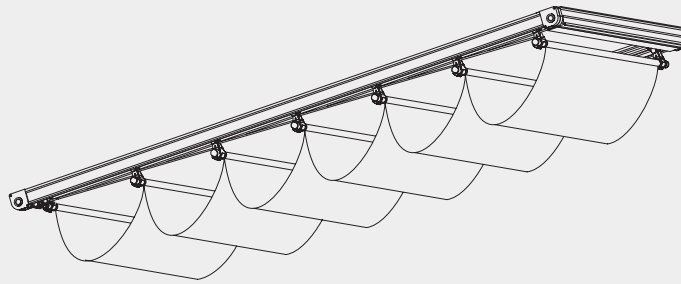

Product Information

- A strong and technically advanced heavy duty glass roof shading system
- Uniform roman blind effect with Silent Gliss technical or decorative fabrics. Large and attractive fabric offer
- Electrically operated system
- Utilising modular and cantilever options, large and unusually shaped glass roofs can be shaded (max surface 50sqm)
- Suitable for applications up to 30° from horizontal
- The system components are made from flame retardant and uv-resistant material
- Can be combined with Radio Remote Control System Silent Gliss 9940/0450



8700

www.shadingspecialists.co.uk

Shading Specialists
Unit 23
Orbital 25
Dwight Road
Watford
WD18 9DA
020 8421 6605

info@shadingspecialists.co.uk

Profile, Bending and Specification Information

Main Carrier Profile

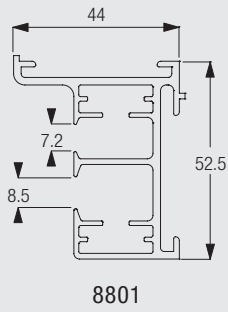

Profile 2151 for motor cover

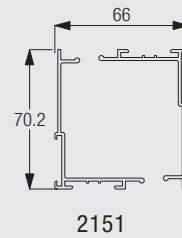

Specification Information - download from Silent Gliss website www.silentgliss.co.uk.

8700 electrically operated skylight system ready assembled with motor enclosed headbox 2151 complete with drive shafts, side guide channels and cross rods for blinds. Side guide channels to be fixed at 60-80cm centres and headbox to be fixed with 3004 clamps and screw fix through headbox 2151. off.....wide xdrop (girth) guide channels, side channels with cross rods atcm intervals.

System Dimensions



5m (overall width)
3m (between side channels)



12m



50sqm



50Kg

Application shapes



Cantilever option allows different application shapes.

Maximum System Measures

Inclination	0°	15°	30°
System length	12m	10m	7m
Profile distance	3m	3m	3m
System width	5m	5m	5m
Max. surface	50m ²	30m ²	20m ²
Max. weight	50kg	30kg	20kg

System Options

Multiple systems

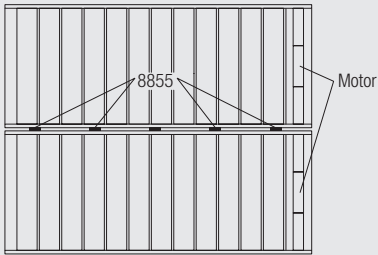

With intermediate bracket 8855 parallel fixing of multiple systems is possible. This modular approach allows shading of unlimited glazed areas.

Please note: each system requires its own motor.

Fitting Information

Bracket positioning

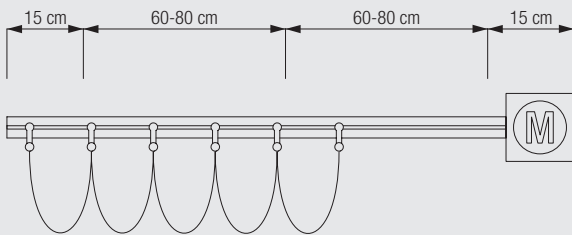

This diagram illustrates the recommended positioning of brackets.

It is likely that customised brackets will be required with this system.

Securing the clamp

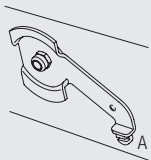

A: Clamps 3044 requires additional fixing with a small screw for maximum security.



8700

Fitting Options

Ceiling fix with clamp 3044

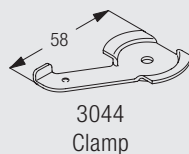
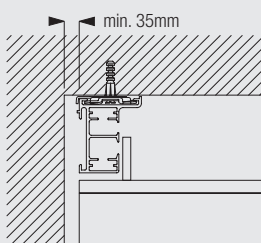

Clamp 3044 requires additional fixing with a small screw for maximum security.

Wall fix with clamp 3044

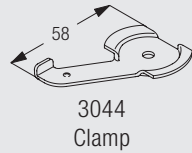
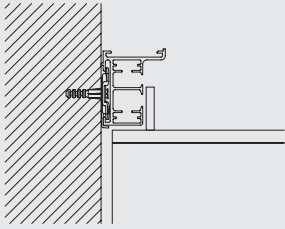

Parallel ceiling fix with intermediate support combination 8855 and clamp 3044 (multiple systems)

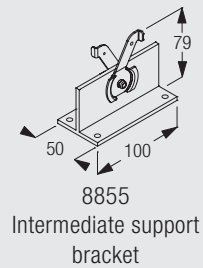
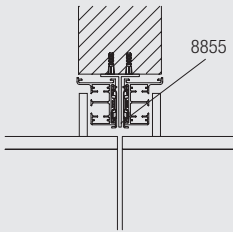

Standard Accessories

0766 In-line connector (complete/no lead)



1003 Profile



2151 Profile



2242 Connector

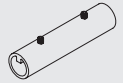

3014 Endcover (22.4mm)



3044 Clamp



8700

3070 Twist eye endstop



8801 Profile



8821 Holder



8825 Holder

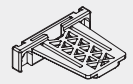

8861 Distance plate

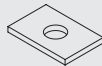

Optional Accessories

0578 Pattress box



0615 Latching switch inc. pattress box



2116 Velcro profile



3603 Top fix bracket

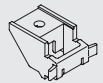

3630 Bracket

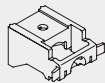

5736 Relay socket

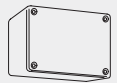

5741 Klik plug



5742 Klik socket



8855 Intermediate support bracket



Useful Measurements

8855 Intermediate support bracket

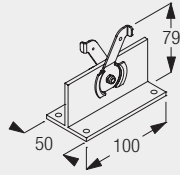

Motorisation

Motor Silent Gliss 9009

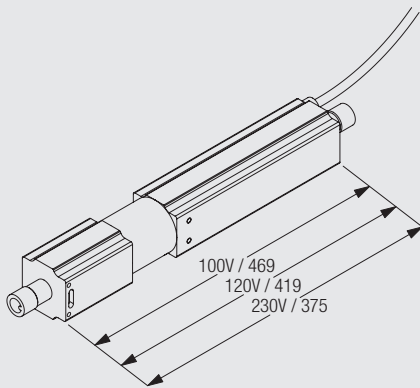

- Torque: 12Nm / 10Nm
- Voltage: 120V / 230V
- Frequency: 60Hz / 50Hz
- Power: 150W / 150W
- Current: 1.35A / 0.66A
- Speed: 30rpm / 35rpm
- Thermal overload protection
- Mechanical end stop

The Silent Gliss 9009 motor is an interference-free motor, designed to offer top performance in regard to strength and reliability.

Operating methods

Operation via fixed switch (single system)

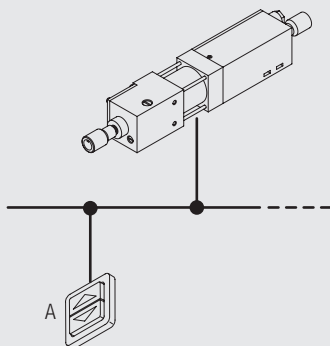

A: Switch and 120/230V supply
All cabling between switch and motor is to be 3 core + earth



8700

Operation via fixed switch (multiple systems)

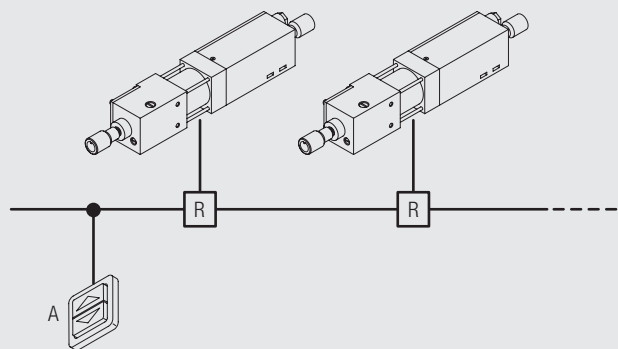

A: Switch and 120/230V supply
All cabling between switch - relay - motor is to be 3 core + earth
R: Relay

Operation with system 9940/0450 radio controls

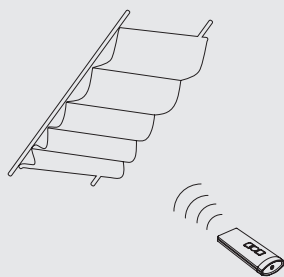

System can be combined with Radio Remote Control Systems Silent Gliss 9940/0450 with minimum wiring. For further details, please refer to catalogue section "Motors & Controls".

Wiring and Connections

Important: Wiring diagrams are available at www.silentgliss.co.uk (password required).



8700